

Farbe:  dunkelgrau-gelb

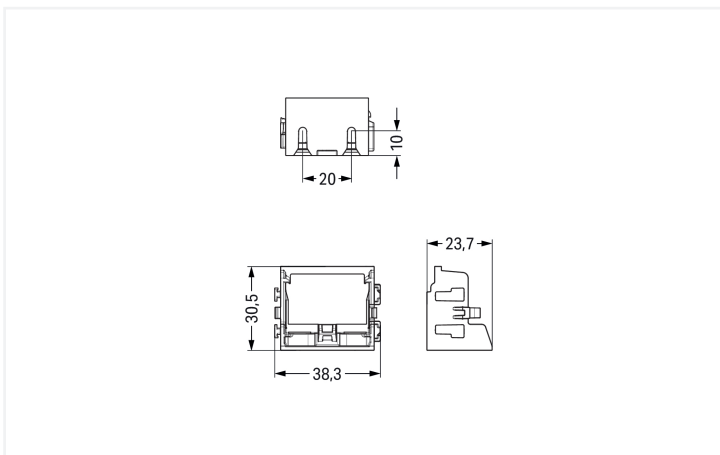
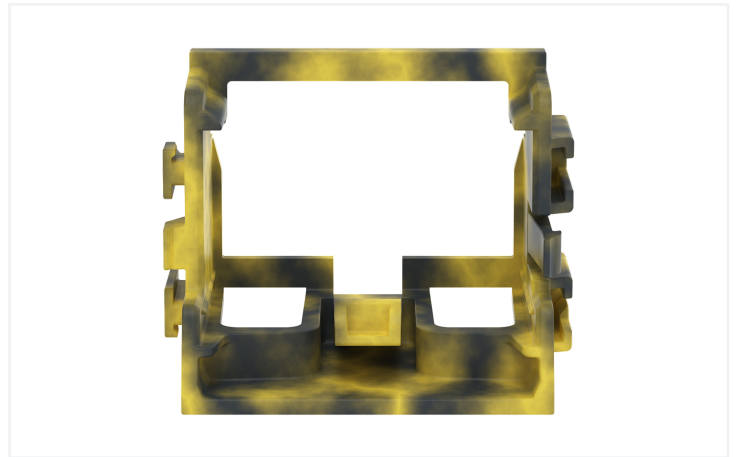
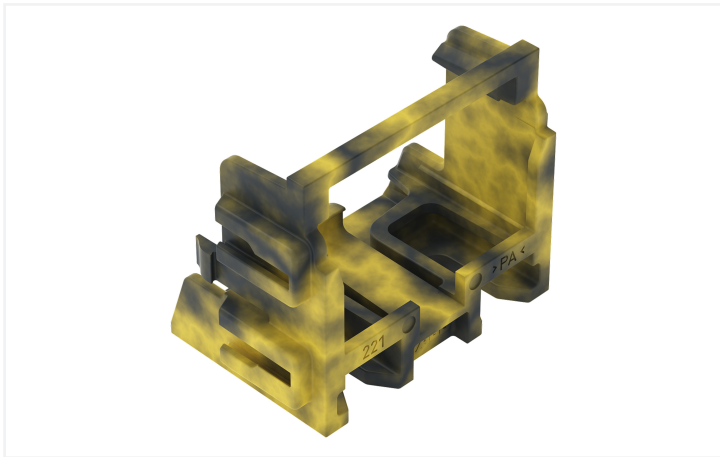

Geometrische Daten

Breite	38,3 mm / 1.508 inch
Höhe	30,5 mm / 1.201 inch
Tiefe	23,7 mm / 0.933 inch

Mechanische Daten

Montageart	Schraubbefestigung
Geeignet	für 10-Leiter-Klemmen (4 mm ²)

Werkstoffdaten

Hinweis Werkstoffdaten	Informationen zu Materialangaben finden sie hier
Farbe	dunkelgrau-gelb
Isolierstoffgruppe	I
Isolierwerkstoff Hauptgehäuse	Polyamid (PA66)
Brennbarkeitsklasse gemäß UL 94	V0
Brandlast	0,144 MJ
Gewicht	4,8 g

Kaufmännische Daten

VPE (UVPE)	10 St.
Verpackungsart	Karton
Ursprungsland	CN
GTIN	4066966603217
Zolltarifnummer	39269097900

Produktklassifikation

UNSPSC	39121421
ETIM 9.0	EC002848
ETIM 10.0	EC002848
ECCN	NO US CLASSIFICATION

Environmental Product Compliance

RoHS Compliance Status	Compliant, No Exemption
------------------------	-------------------------

Downloads

Environmental Product Compliance

Compliance Search	
Environmental Product Compliance 221-509/002-053	↓

CAD/CAE-Daten

CAD Daten

2D/3D Modelle
221-509/002-053



1 Passende Produkte

1.1 Optionales Zubehör

1.1.1 Beschriftung

1.1.1.1 Beschriftungsstreifen



Art-Nr.: 210-833

Beschriftungsstreifen; 25 m auf Rolle; 6 mm breit; unbedruckt; Selbstklebend; weiß